

**INSTRUCCIONES – MANUAL DE INSTRUÇÕES
INSTRUCTIONS**

ZANUSSI

LAVADORAS AUTOMATICAS

**MÁQUINAS DE LAVAR
A ROUPA**

WASHING MACHINES

FLS 432 C

FLS 522 C

CONTENTS

Technical specifications	Pág.	22
Warnings	Pág.	23
Unpacking and installation	Pág.	24
Transit security bars	Pág.	24
Hydraulic connection	Pág.	24
Levelling	Pág.	25
Electrical connection	Pág.	25
Descriptions of the controls	Pág.	26
Control panel	Pág.	26
Use of controls	Pág.	26
Washing powder dispenser	Pág.	26
On/off lamp	Pág.	26
«1/2 load» button	Pág.	26
«no spinning» button	Pág.	26
Temperature selector	Pág.	26
Program selector	Pág.	26
How to use controls detergent and additives	Pág.	27
Loading the washing machine	Pág.	27
Dose de washing powder	Pág.	27
Dose the additives	Pág.	27
Select the temperature	Pág.	27
Select the program	Pág.	27
Start	Pág.	27
Stop	Pág.	27
Programs for cotton and linen	Pág.	28
Programmes for synthetics, mixed and wool	Pág.	28
Washing hints	Pág.	29
Load the washing machine	Pág.	29
Temperatures	Pág.	29
Table of symbols	Pág.	29
Maintenance and cleaning	Pág.	30
External cleaning	Pág.	30
Cleaning the dispenser drawer and the recess	Pág.	30
Cleaning the drain filter	Pág.	30
Cleaning the water inlet hose filter	Pág.	30
The dangers of freezing	Pág.	30
Servicing	Pág.	31

TECHNICAL SPECIFICATIONS

DIMENSIONS	Width	60 cm
	Height	85 cm
	Depth	55 cm
ELECTRICAL CONNECTION	Voltage	220...230 V 50Hz
	Max.Power Absorbed	2.200 W(10A)
WATER PRESSURE	Minimum	5N/cm ²
	Maximum	80N/cm ²
MAXIMUM RECOMMENDED LOAD	Cotton, Linen	4,5 kg
	Synthetics delicate fabrics	2 kg
	Wool	1 kg
SPIN SPEED	MOD.: FLS 432 C	Maximum 400 r.p.m.
	MOD.: FLS 522 C	500 r.p.m.

This appliance marked "CE" complies with the directives:
-89/336/CEE on electro magnetic compatibility.
-73/23/CEE on electric material designed to be used with certain power limits.

WARNINGS

THESE WARNINGS ARE PROVIDED IN THE INTEREST OF SAFETY. YOU MUST READ THEM CAREFULLY BEFORE INSTALLING OR USING THE APPLIANCE.

It is most important that this instruction book should always be at hand for the user for reference. Should the appliance be sold or transferred to another owner, or should you move house and leave the appliance, always ensure that the book is left with the appliance in order that the new owner can get to know the functioning of the appliance and the relevant warnings.

CHECK THE APPLIANCE UPON RECEPTION AND SHOULD ANY DAMAGE BE OBSERVED CALL YOUR DISTRIBUTER BEFORE YOU MAKE IT WORK.

- Children must not be allowed to temper with the controls or play with the product.
- The appliance is heavy. Care should be taken when moving it. Do NOT hold yourself on the controls.
- All packing and transit bolts must be removed before use.
- Serious damage can occur to the product and to property if this has not been adhered to. See relevant section (unpacking) in the instruction booklet.
- The washing machine must be unplugged when removing the interior transit bolts. Do not plug the appliance before finishing the removal of the transit bolts and the fixing of the caps in the holes where the security bolts were.
- If the appliance is to stand on a carpeted floor make sure that there is space between the carpet and the supporting feet of the appliance for the air to circulate freely around .
- Any electrical and/or plumbing work required to install this appliance should be carried out by a qualified electrician and/or plumber or competent person.
- It is dangerous to alter the the specifications or attempt to modify this product in any way.
- Care must be taken to ensure that the appliance dos not stand on the electrical supply cable.
- Only wash fabrics which are designed to be machine washed. If in doubt, consult the manufacturer of that item.
- Before washing ensure that all pockets are empty and buttons and zips are fastened.
- Any objects such as coins, safety pins, nails, screws, stones or any other hard, sharp material can cause extensive damage and must not be placed into the appliance nor left in the pockets.
- Avoid washing frayed or torn articles and treat stains such as paint, ink, rust, and grease before washing.
- Garments which have been in contact with volatile petroleum products should not be machine washed. If volatile cleaning fluids are used, care should be taken to ensure that the garemnet is dry before placing in the washing machine.
- Wash small items such as socks, laces, washable belts , etc. in a washing bag or pillow case as it is possible for such items to slip down between the tub and the inner drum.
- Only wash the advised quantity of delicate fabrics. Damage to the fabric can ensue if you over-fill. Refer to the manufacturer's recommendations of quantities.
- Do not overload the appliance, see the relevant WASHING PROGRAM section .
- Pets have been known to climb into washing machines. Please check your drum before use.
- The glass door becomes very hot during the wash cycle. Keep children away from the appliance whilst it is in operation.
- Before opening the door look through the "window" to check if the water has been drained. Should there be water do not open before draining. If in doubt read section "INSTRUCTIONS FOR USE".
- Always unplug the appliance and turn off the water after use.
- Leave the porthole slightly ajar between washes to preserve the door seal.
- Unplug the appliance before cleaning.
- This product must be serviced by an authorised Service Centre, and only genuine spare parts should be used. Do not try to repair the appliance yourself.
- Repairs carried out by inexperienced persons may cause injury or serious malfunctioning of the machine. Contact your local Service Centre. Always insist on genuine spare parts.

UNPACKING AND INSTALLATION

TRANSIT SECURITY BARS

Before starting the machine up, **the transport security bars must be removed** as follows:

You are advised to keep all the transport security bars in case the appliance has to be transported again.

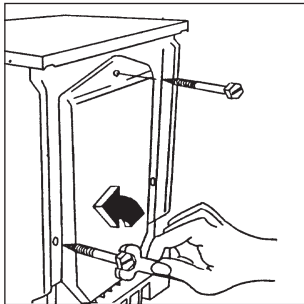

1. Unscrew and remove the three rear screws by means of a key.

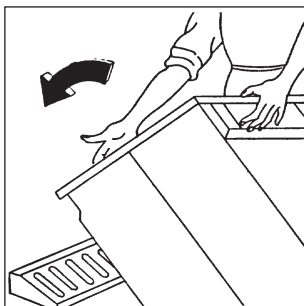

2. Lean the appliance back on the rear and fit one of the polystyrene angles between the appliance and the floor.

Make sure the hoses are not squashed.

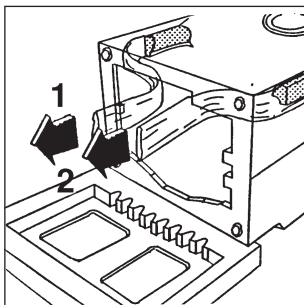

3. Carefully remove the plastic bags on the right and the left, pulling them to the centre of the appliance.

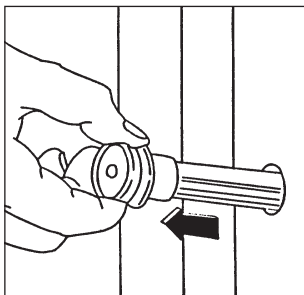

4. Place the machine in an upright position and remove the three plastic bolts.

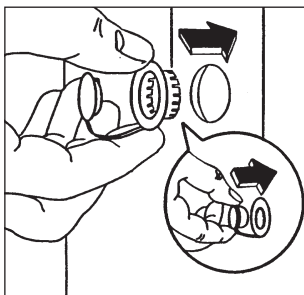

5. Plug the 3 holes with the plastic plugs which you can find in the envelope containing the instruction booklet.

HYDRAULIC CONNECTION

There should be a **COLD WATER** tap near the washing machine with a screwing on connection pipe of 3/4 gas for the water supply, a sink, a wash basin or a drainage system in the wall.

Previously check if:

- it is not a hot water tap.
- the running water is clean. If not, run off a reasonable amount of water to flush out any debris that may have collected in the pipes.

Have the permanent drainage system in the wall checked by a plumber.

Place the enclosed rubber joint, delivered in a plastic bag together with the appliance (A) Fig.6), at the very end of the inlet hose and carefully screw the pipe to the tap taking care not to damage the screwdrive and fix the nut well on to the end in order to avoid leaking.

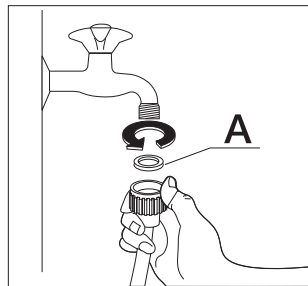

If necessary turn the hose adequately by unscrewing the nut at the rear of the appliance.

Now tighten the nut anew to avoid leaks. (Open the tap and assure that it does not leak and close it again.)

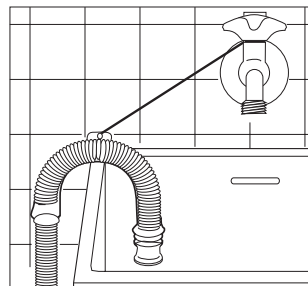

Place the discharging hose in a washbasin or sink with the aid of the bent piece delivered separately. The bent piece has to be entered into the tube's mouth in order to assure the support. Aforesaid piece allows the hose to be fixed to the wall by means of an opening on the upper part and that way the hose does not move and its falling is avoided.

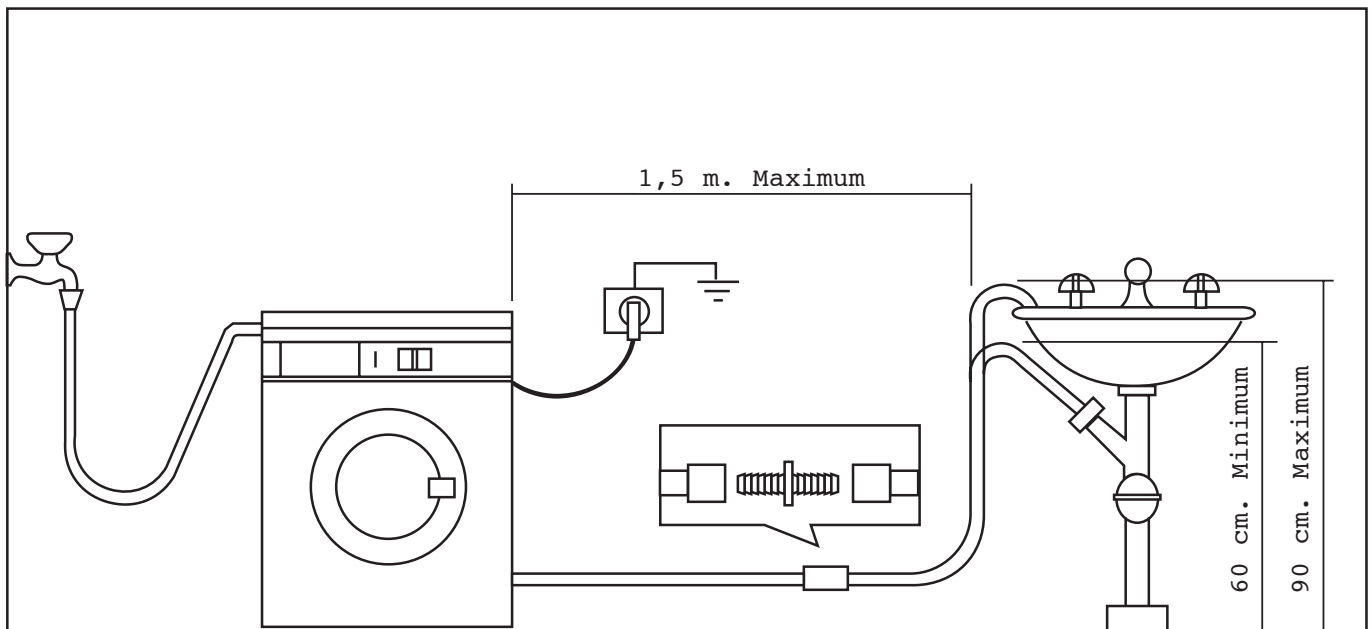

IMPORTANT: The distance from the floor to the highest part of the hose should be between 60 to 90 cm. (It is advised to be between 60 and 70 cm). The hose must not be bent nor twisted to avoid clogging. Should a prolongation of the discharging hose be unavoidable this must never surpass 1.5 m and must be of the same diameter as the original hose.
Make sure the hoses are not too tense.

LEVELLING

Level the appliance by loosening or tightening the feet. Once in the right position fix the feet by pushing the nuts against the base of the case. Accurate levelling will prevent vibration, noise and displacement of the appliance during operation.

Some vibration is inevitable, especially if placed on a wooden floor. Wooden floors are particularly susceptible to vibrations. For advice, consult a builder. If possible always place the appliance on a solid floor.

ELECTRICAL CONNECTIONS

Before plugging the appliance make sure that:

- 1° the mains of your installation is the same as on the rating plate of your appliance (the plate is stuck to the rear of the appliance).
- 2° The meter, the fuses, the wiring and the socket outlet can support the max. power absorbed stated on the rating plate.
- 3° The socket base and the plug must fit in adequately without any reducing interposition, multiple outlets or adapters. If necessary replace the socket outlet by an adequate one.

The applicable rules for electrical security require an adequate earthing. The plug of the appliance is provided with such a device.

Make sure your socket outlet is provided with an adequate earthing too.

The manufacturer declines any liability in case of accidents or incidents should these safety measures not be observed.

(Never touch the washing machine or any electric appliance while standing on a wet floor or being barefoot.)

DESCRIPTION OF THE CONTROLS



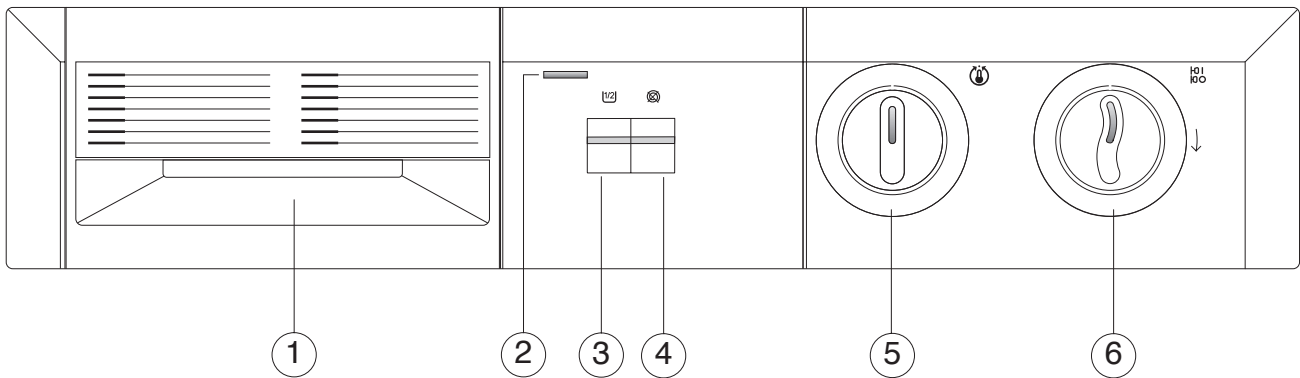

Control panel

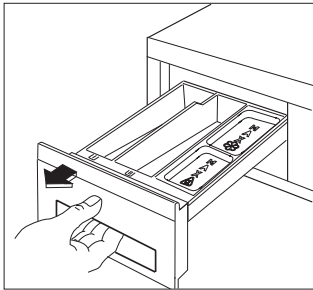

1. WASHING POWDER DISPENSER



The dispenser is provided with 4 compartments marked with the following symbols:

-  «Prewash» symbol shows the compartment for the prewash detergent.
-  «Wash» symbol shows the compartment for the washing detergent.
-  «smooth» symbol shows the compartment for the smoothing additives.
-  «bleach» symbol shows the compartment for the bleaching additives.

2. ON/OFF LAMP

It lights when the appliance is operating.

3. 1/2 LOAD BUTTON

Pressing this button before starting the intense program there will be one rinse less which leads to energy and water saving.

4. “NO SPINNING” BUTTON

Pressing this button before starting the intense washing program all spinnings will be excluded. The other steps of the program remain unchanged.

5. TEMPERATURE SELECTOR

This control allows you to select the temperature of the washing cycle in accordance with the kind of clothes to be washed.

Turn the control until the required temperature coincides with the marker.

On the program table you will find the most appropriate temperature for each kind of washing. Selecting * any program can be run through with cold water. This will ensure a saving in electricity consumption.

6. PROGRAM SELECTOR

To select the required program turn the control clockwise until the marker on the top coincides with the number of the required program (reference mark on the control panel). If at any chance you pass by the required number **NEVER TURN THE CONTROL ANTICLOCKWISE** just continue clockwise until the required number is reached again.

HOW TO USE THE CONTROLS DETERGENT AND ADDITIVES

1. LOADING THE WASHING MACHINE

Load the laundry loosely, alternating large items with small ones.

Do not overload the washing machine, but always try to use its utmost capacity in accordance with the type of fabric. Reduce the quantity when washing very dirty or fluffy laundry .

Once the machine is working and you wish to add any item you must stop the program.

IMPORTANT REMARK: This appliance is provided with a security device to avoid opening during the cycles. Open it only when absolutely necessary and wait 2 to 3 minutes after you have stopped the machine to give the safety device time to unlock.

2. DOSE THE WASHING POWDER

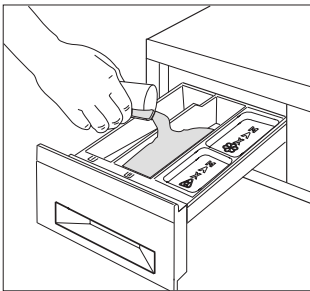



Pull the handle to open the dispenser. Enter the advised quantity of washing powder into compartment 

For prewash use compartment 

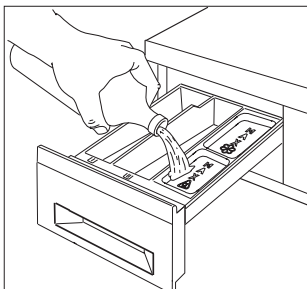
3. DOSE THE ADDITIVES



If you wish to use additives enter the softener in the compartmente with the symbol  and the bleacher in the compartment with the symbol  Never exceed the MAX level.

4. SELECT THE TEMPERATURE

Turn the dial clockwise to the desired temperature .

5. SELECT THE PROGRAM

Turn the dial clockwise until the marker reaches the desired program.

6. START

Before pressing the On/off Button check if:

The door is properly closed.

The appliance is plugged in.

The water supply tap is turned on.

The drain filter is tight.

The drain hose is adequately positioned.

Pull the program dial up to you till it clicks.

The pilot light comes on and the program will begin.







7. STOP

The washing machine stops automatically once the cycle is finished, the pilot goes out. **Open the door 2 to 3 minutes after the end of the program to give the safety device time to unlock.**

Close the tap and unplug the appliance. Leave the door ajar for a few minutes for the steam to get out.

PROGRAMS FOR COTTON AND LINEN







Recommended load: max. 4,5 kg.

PROGRAM	DEGREE OF SOIL	COMPARTMENTS TO USE	MAXIMUM WATER TEMP.	POSITION PROGRAM	DESCRIPTION
WHITES with prewash	heavy soil		90	1	Prewash Wash at 90°C 4 rinses Spin 5 min.
WHITES without prewash	normal soil		90	2	Wash at 90°C 4 rinses Spin 5 min.
FAST COLOURS	normal soil		60	2(•)	Wash at 60°C 4 rinses Spin 5 min.
NON-FAST COLOURS	normal soil		40	3	Wash at 40°C 4 rinses Spin 5 min.
RINSES				4	Load bleacher 4 rinses Spin 5 min.
ADDITIVES SOFTENER				5	load additif 1 rinse Spin 5 min.
SPIN				6	Drain water Spin 2.5 min.

(•) This 60° programme is the reference programme for the Energy label according to the article 2, paragraph 1 of the EEC Directive 92/75.

PROGRAMS FOR SYNTHETICS, MIXED AND WOOL

Recommended load: max. 2 kg (wool max. 1 kg.)

PROGRAM	DEGREE OF SOIL	COMPARTMENTS TO USE	MAXIMUM WATER TEMP.	POSITION PROGRAM	DESCRIPTION
MIXED FABRICS	heavy soil		60	7	Prewash at 30°C Wash at 60°C 3 rinses Stop with water in the drum
FAST COLOURS	normal soil		60	8	Wash at 60°C 3 rinses Stop with water in the drum
SYNTHETICS DELICATES	normal soil		40	9	Wash at 40°C 3 rinses Stop with water in the drum
WOOL SILK	normal soil		40	10	Wash at 40°C 3 rinses Stop with water in the drum
RINSES DELICATES				11	3 rinses Stop with water in the drum
ADDITIVES SOFTENER				12	Load additif 1 rinse Stop with water in the drum
DRAIN				13	Drain water drum stands still

For draining the water, once the cycle is finished, situate the timer "13" right in its place.

WASHING HINTS

Sort the laundry according to the type of fabric, colour fastness and how dirty it is.

When washing curtains remove the hooks.

It is essential to wash new coloured items separately when washing them for the first time.

When washing fabrics requiring different wash temperatures together, always select the lowest one.

White items should NOT be washed with coloured ones.

For wool use gentle detergents only in small quantities. Only wool marked 'PURE NEW WOOL WASHABLE PRESHRUNK' can be washed in the machine using the wool program; other types of wool should be washed by hand or dry cleaned.

Some stains such as fruit, wine, grass, rust, blood, etc. are difficult to remove and should be treated before washing with specific products which can be found in most household shops. In any case they should be treated immediately, later on they are difficult to remove.

Damp laundry should be hung out to dry as soon as possible after finishing the wash.

Knitwear and woollens should be dried flat, away from direct sunlight.

On the care labels in most clothes wash code symbols can be found which help you to select the adequate wash program. You are advised to observe and follow these instructions.

On the following table you will find the meaning of the symbols.

LOAD THE WASHING MACHINE

Check the quantity you are going to wash for each cycle.

It is rather difficult to weigh all the pieces to be washed. We therefore advise you:

Cotton and linen: fill the drum without pressing.

Synthetic resistant : fill two thirds of the drum.

Delicates and wool: fill half the drum.

TEMPERATURES

You are advised to wash whites at a temperature of 60°C. If the laundry is not very soiled this will be enough and it is energy saving. If you want to wash whites without temperature, you must choose the program 2.

































Coloured fabrics are advised to be washed at 40°C although they would stand 60°C.

When washing together dark and light colours the temperature should not exceed 40°C. Synthetic white and light coloured fabrics can be washed at 60°C, but here also 40° will do if they are not very soiled.

Dark synthetics, delicate fabrics and wool must be washed at a temperature lower than 40°C. If one of the labels is marked 30°C, select 30°C for the whole cycle.

TABLE OF SYMBOLS

The symbols on the labels are of great help for the wash, care and treatment.

<p>STRONG WASH</p>  <p>DELICATE WASH</p> 	 <p>Max. wash temp. 95°C</p> 	 <p>Max. wash temp. 60°C</p> 	 <p>Max. wash temp. 40°C</p> 	 <p>Max. wash temp. 30°C</p> 	 <p>Hand wash</p>	 <p>Do not wash at all</p>	
 <p>BLEACHING</p>	 <p>Bleach in cold water</p>			 <p>Do not bleach</p>			
 <p>IRONING</p>	 <p>Hot iron max. 200°C</p>	 <p>Hot iron max. 150°C</p>	 <p>Hot iron max. 100°C</p>	 <p>Do not iron</p>			
 <p>DRY CLEANING</p>	 <p>Dry cleaning in all solvents</p>	 <p>Dry cleaning in perchlorethylene, petrol, pure alcohol, R 111 y R 113</p>	 <p>Dry cleaning in petrol, pure alcohol, R 111 y R 113</p>	 <p>Do not dry cleaning</p>			
 <p>DRYING</p>	 <p>Flat</p>	 <p>On the line</p>	 <p>On clothes hanger</p>	 <p>High temperature</p>	 <p>Low temperature</p>	 <p>Tumble dry</p>	 <p>Do not tumble dry</p>

MAINTENANCE AND CLEANING

Before any maintenance or cleaning is carried out you must **DISCONNECT** the appliance from the electricity supply.

EXTERNAL CLEANING

Clean the exterior cabinet of the appliance with neutral soap and water only, and then try thoroughly.

CLEANING THE DISPENSER DRAWER AND THE RECESS

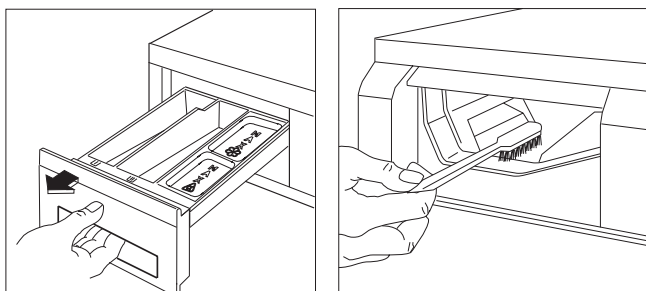

Pull the drawer to remove (slightly at first till the stop, then pull hard).

Flush well under a fast running tap.

Clean the recess with a small brush.

Replace the drawer.

CLEANING THE DRAIN FILTER

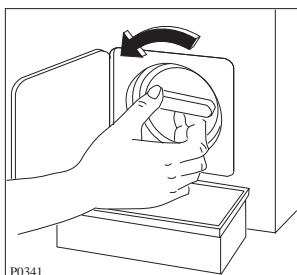

A clean filter is important for correct functioning of the washing machine, and it should therefore be cleaned regularly. Small objects left in the pockets and yarn are retained here.

Unscrew the filter completely turning it anticlockwise.

Remove the filter and clean it under a fast running tap.

Replace the filter turning now clockwise and tighten it.

CLEANING THE WATER INLET HOSE FILTER

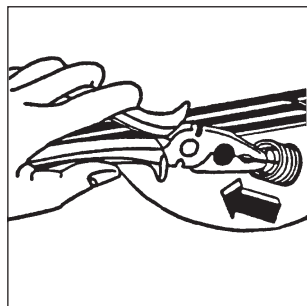

If it takes longer to fill up the washing machine it is time to check the water inlet hose filter it may be clogged. Turn off the water tap. Unscrew the fixing nut of the inlet hose. Remove the filter from the electrovalve and clean it with a hard bristle brush and replace it. Screw on the nut thoroughly.

THE DANGERS OF FREEZING

If the machine is exposed to temperatures below 0°C, certain precautions should be taken.

- * Turn off the water tap and unscrew the inlet hose.
- * Select a wash program and run for a few seconds.
- * Position the end of the drain hose in a bowl on the floor.
- * Run the draining program for a few seconds.

This way you make sure now water at all remains in the appliance which could freeze and thus damage it and its surroundings.

When you need to start the machine up again, make sure that the room temperature is above 0°C.

SERVICING

Before contacting your local Service Force Centre, check your machine against the simple maintenance guidelines given below.

The appliance does not start up

- * Check if the door is closed properly.
- * Check if the appliance is plugged in.
- * Check the fuse.
- * Check if the program dial is in the correct position.

THE MACHINE DOES NOT FILL

- * Check if the water tap is on.
- * Check if the tap is clogged.
- * Check if the inlet hose is bent.
- * Check if the water inlet filter is clogged.

THE MACHINE EMPTIES AS IT FILLS

- * The end of the drain hose is too low (see page. 25)

THE MACHINE DOES NOT DRAIN OR SPIN

- * Check if the drain hose is bent or squashed.
- * Check if the drain filter is clogged.
- * Check if the selected program includes spinning.
- * Check if the 'Rinse Hold' button is pressed.

THE MACHINE LEAKS OR OVERFLOWS

- * Too much washing powder.
- * Unsuitable washing powder.
- * Check the joints for leaks. It is rather difficult to see the water running along a hose.

THE MACHINE VIBRATES OR IS NOISY

- * Check if all transport devices have been removed.
- * Check if the appliance touches the walls or furniture.
- * Check if the legs are adequately levelled and the nuts tight

If, after above checks, there is still a fault, call your Local Service Centre. Please make sure you give the model and serial number of the appliance and the purchasing date.

IMPORTANT REMARK: This washing machine is provided with the latest technical advances in washing and water level reduction. It is quite right that you do not see the water through the door.

